

Data Sheet



Article number: 20331342

Description: E+G Handwheel
GN 555-250-B24-D

Measures

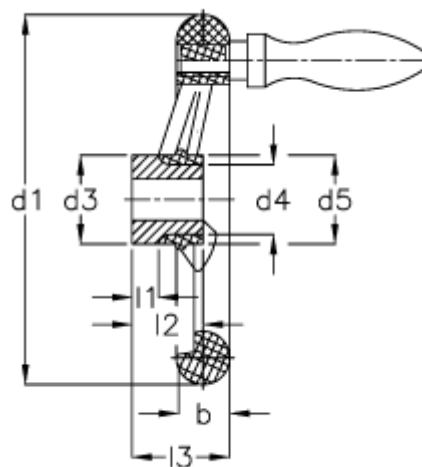
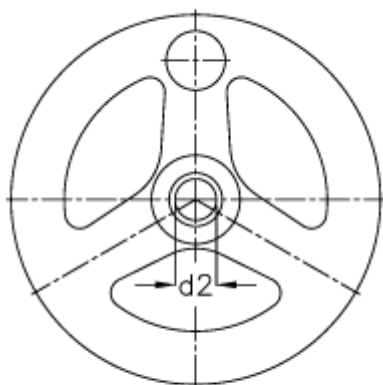

b	= 29	l1 -0.5	= 7
d1	= 250	l2 -0.5	= 36
d2 H7	= 24	l3	= 58
d2 H7	= 22	Number of spokes	= 3
d3	= 49		
d4	= 38		
d5	= 56		
Handle	= 32		